

**BRYSTON**

**BDP-π** Digital Music Player

Owner's Manual



## IMPORTANT SAFETY INSTRUCTIONS



The lightning flash with arrowhead symbol within an equilateral triangle, is intended to alert the user to the presence of un-insulated "dangerous voltage" within the product's enclosure that may be of sufficient magnitude to constitute a risk of electric shock to persons.



The exclamation point within an equilateral triangle is intended to alert the user to the presence of important operating and maintenance (servicing) instructions in the literature accompanying the product.

1. Read these instructions.
2. Keep these instructions.
3. Heed all warnings.
4. Follow all instructions.
5. Do not use this apparatus near water.
6. Clean only with dry cloth.
7. Do not block any ventilation openings. Install in accordance with the manufacturer's instructions.
8. Do not install near any heat sources such as radiators, heat registers, stoves, or other apparatus (including amplifiers) that produce heat.
9. Do not defeat the safety purpose of the polarized or grounding-type plug. A polarized plug has two blades with one wider than the other. A grounding type plug has two blades and a third grounding prong. The wide blade or the third prong are provided for your safety. If the provided plug does not fit into your outlet, consult an electrician for replacement of the obsolete outlet.
10. Protect the power cord from being walked on or pinched particularly at plugs, convenience receptacles, and the point where they exit from the apparatus.
11. Only use attachments/accessories specified by the manufacturer.
12. Use only with the cart, stand, tripod, bracket, or table specified by the manufacturer, or sold with the apparatus. When a cart is used use caution when moving the cart/apparatus combination to avoid injury from tip-over.
13. Unplug this apparatus when moving it & during lightning storms or when unused for long periods of time.
14. Refer all servicing to qualified service personnel. Servicing is required when the apparatus has been damaged in any way, such as power-supply cord or plug is damaged, liquid has been spilled or objects have fallen into the apparatus, the apparatus has been exposed to rain or moisture, does not operate normally, or has been dropped.



**WARNING: TO REDUCE THE RISK OF FIRE OR ELECTRIC SHOCK, DO NOT EXPOSE THIS APPARATUS TO RAIN OR MOISTURE.**

**DO NOT EXPOSE THIS EQUIPMENT TO DRIPPING OR SPLASHING AND ENSURE THAT NO OBJECTS FILLED WITH LIQUIDS, SUCH AS VASES, ARE PLACED ON THE EQUIPMENT.**

**TO COMPLETELY DISCONNECT THIS EQUIPMENT FROM THE AC MAINS, DISCONNECT THE POWER SUPPLY CORD PLUG FROM THE AC RECEPTACLE.**

**THE MAINS PLUG OF THE POWER SUPPLY CORD SHALL REMAIN READILY OPERABLE.**

**UNPLUG MAINS CORD DURING TRANSPORTATION.**

## BRYSTON LIMITED WARRANTY

Bryston analog audio circuits are warranted to be free from manufacturing defects for twenty (20) years from the original date of manufacture. The warranty includes parts and labour.

Bryston Digital circuits and cables are warranted for five years from the original date of manufacture. The warranty includes parts and labour.

Bryston products having motorized moving parts, excluding motorized volume controls, are warranted for three years from the original date of manufacture. The warranty includes parts and labour.

Bryston will remedy the problem by repair or replacement, as we deem necessary, to restore the product to full performance. Bryston will pay only return shipping costs for the full length of the specific products warranty.

In the event of a defect or malfunction, contact Bryston's repair centers for return authorization. Products must be returned using original packaging material only. Packing material may be purchased from Bryston if necessary. This warranty is considered void if the defect, malfunction or failure of the product or any component part was caused by damage (not resulting from a defect or malfunction) or abuse while in the possession of the customer. Tampering by persons other than factory authorized service personnel or failure to fully comply with Bryston operating instructions voids the warranty.

This warranty gives you specific legal rights and you may also have other rights which may vary from province to province and country to country. As of 2006-02-22 Bryston will only warranty Bryston products purchased through authorized Bryston dealers. Bryston products with a date code of 0608 or higher (date code format is "yyww", where "yy" is the two least significant digits of the year and "ww" is the week of the year) must be accompanied by a copy of the bill-of-sale from a Bryston authorized dealer to qualify for warranty service. The warranty is transferable from the original owner to a subsequent owner as long as a copy of the bill-of-sale from the original authorized Bryston dealer accompanies the re-sale. The copy of the bill of sale to any subsequent owner need ONLY include the Name of the Bryston Authorized Dealer and the Model and Serial number of the Bryston product. The warranty will only be honored in the country of the original purchase unless otherwise pre-authorized by Bryston.

### BRYSTON SERVICE in CANADA:

Postal address: **PO. BOX 2170, Stn. Main  
PETERBOROUGH, ONTARIO  
CANADA K9J 7Y4**

Courier address: **677 NEAL DRIVE  
PETERBOROUGH, ONTARIO  
CANADA K9J 6X7**

PHONE: 705-742-5325  
FAX: 705-742-0882  
E-mail: [cdnser@bryston.ca](mailto:cdnser@bryston.ca)

### BRYSTON SERVICE in the USA:

**79 COVENTRY ST., Suite 5  
NEWPORT, VERMONT  
U.S.A. 05855-2100**

PHONE: 802-334-1201  
FAX: 802-334-6658  
E-mail: [usaser@bryston.ca](mailto:usaser@bryston.ca)

### BRYSTON SERVICE outside Canada and the USA:

contact your local distributor or

CHECK OUR WEB SITE: [www.bryston.ca](http://www.bryston.ca)  
E-MAIL BRYSTON DIRECTLY: [cdnser@bryston.ca](mailto:cdnser@bryston.ca)  
FAX BRYSTON DIRECTLY: 01-705-742-0882  
PHONE BRYSTON DIRECTLY: 01-705-742-5325

## Table of Contents

|                                     |    |
|-------------------------------------|----|
| General.....                        | 4  |
| Welcome .....                       | 4  |
| Features .....                      | 4  |
| Firmware Updates.....               | 4  |
| Display Modes .....                 | 5  |
| Connecting To Your System .....     | 5  |
| Audio Connection.....               | 5  |
| Local Storage Connection.....       | 6  |
| Network Connection .....            | 6  |
| Wireless Bridge .....               | 6  |
| Network Attached Storage.....       | 6  |
| Front Panel Menu Navigation .....   | 7  |
| Front and Rear Panel.....           | 8  |
| Display: .....                      | 8  |
| Infrared Sensor: .....              | 8  |
| Left / Right Button:.....           | 8  |
| Up / Down Button:.....              | 8  |
| Option Button: .....                | 8  |
| Power LED: .....                    | 8  |
| USB Ports:.....                     | 8  |
| HDMI Output: .....                  | 9  |
| Ethernet Connector: .....           | 9  |
| Infrared Transmitter Output: .....  | 9  |
| S/PDIF Digital Audio Output: .....  | 9  |
| Toslink Optical Audio Output: ..... | 9  |
| Status Light: .....                 | 9  |
| Power Switch:.....                  | 9  |
| DC Power Connector: .....           | 9  |
| Dimensions.....                     | 9  |
| Software Introduction.....          | 10 |
| Media Player .....                  | 10 |
| Now Playing.....                    | 10 |
| Stored Playlists.....               | 11 |
| Alternate Views.....                | 11 |
| Adding Music to Library .....       | 11 |

## General

### Welcome

Thank you for your purchase of a Bryston BDP-π; a state-of-the-art digital music player that can play back the vast majority of digital music file formats including today's most popular lossless codecs including AIFF, FLAC, WAVE, APPLE LOSSLESS, and more at resolutions up to 192kHz / 24 bit PCM.

Music stored on both locally attached USB media and network attached storage (NAS) devices is aggregated and indexed into a single library. The BDP-π includes intuitive software for controlling your BDP that requires no installation and is accessible from any modern web browser. A wide variety of compatible third-party applications are also available for iOS and Android mobile devices. In stand-alone systems, the BDP-π can also be controlled via front-panel buttons and the color TFT display, or with our optional BR-2 IR remote control.

We have designed the BDP-π to provide the highest sound quality possible and an enjoyable user experience free from the hassles normally associated with computer-based audio playback.

A Quick Start Guide has been provided to help you setup and play music right away. This manual provides a technical reference for hardware, setup, interconnectivity, warranty, and safety. Bryston stands committed to ongoing improvement and software development. For that reason, we have separated the Firmware User's Manual in which you'll find detailed information on day to day use from this document. See [www.bryston.com](http://www.bryston.com) for the most current edition.

Again, thank you for choosing Bryston.

### Features

Extensive technical research and development has been undertaken to ensure the highest quality playback and durability of your BDP-π. The following details describe some of these features.

- Power with included SMPS or with custom Bryston power supply.
- Four USB 2.0 (backwards compatible with USB 1.1 and 1.0 specifications) ports.
- Wide variety of control options including:
  - Front panel push button controls
  - Responsive web interface compatible with iOS, Android, Macintosh, and windows devices
  - Third party app compatibility with diverse software such as MPoD and MPaD for iOS, and MPDroid for Android.
  - IR Remote control such as Bryston's BR-2 or other universal remote controls.
- Interconnectivity with USB Class 2.0 digital to analog converters.
- Extensive compatibility with different music file formats. See current firmware manual for details.
- User upgradeable firmware
- Compatible with USB hard disk, and solid-state storage media as well as network attached storage.
- Compact size and cosmetic unity with other Bryston products.

### Firmware Updates

BDP-π firmware updates will periodically become available from Bryston. Upon availability, the Dashboard on the web interface will notify you. To identify which version of firmware you are currently running, you may either use the front panel, or the web interface. To determine the current version of the firmware from the front panel, see the bottom

line of text on the home screen. The example indicates that the firmware version is S2.01 2016-02-12.



To discover your current firmware version from the Bryston Web Interface, please consult your Firmware User's Manual.

## Display Modes

Your BDP-π is equipped with a color TFT display. Toggle between each of three display modes by pressing both the ◀▶ and ▲▼ buttons at once then immediately releasing when the screen goes black. The default display mode facilitates menu based navigation for settings adjustment. See "Front Panel Menu Navigation" on page 7 for a full menu map.

The album art display mode shows the currently playing track's album art. The art is read from a JPG file contained within the folder in which the currently playing track resides.

The VU meter mode shows two vertical bars which rise and fall with the instantaneous relative output level of each channel during playback.

The display is automatically disabled during playback when connected to a USB DAC. This is a compatibility feature to ensure high quality playback with USB DACs.

## Connecting To Your System

The BDP-π is designed for the explicit purposes of playing back your digital music library in a bit-perfect manner. As a very precisely engineered digital audio device, sound quality can vary based on the digital to analog converter to which it is

connected. A high quality converter such as those offered by Bryston are recommended. Compatible digital to analog converters will have at least one of the following input types:

- S/PDIF (digital coax) with RCA or BNC type connector
- TOSLINK optical connector
- HDMI
- USB Audio 2.0

The BDP-π also requires that you store and organize your music library on a connected USB drive and/or via network attached storage.

Thus, the minimum hookup requirements include attaching a music storage device like a portable hard drive and DAC such as the BDA2 to the BDP-π and connecting your BDP-π to your home network for control.

## Audio Connection

Prior to powering on your BDP-π, connect your BDP-π to your DAC using one of the four different methods described above. The most desirable connection depends on your DAC. Typically, S/PDIF will be better sounding than TOSLINK. USB offers very high sound quality (perhaps even superior to S/PDIF) when coupled with asynchronous USB DACs such as Bryston's own BDA-2 and BDA-3. HDMI is limited to a maximum sample rate of 48kHz and bit depth of 16. When using USB, a cable with a USB "A" Type connector on the BDP-π end, and the end specified by the DAC manufacturer on the other. For a Bryston BDA, that is a "B" Type connector. If your USB DAC does not receive signal, use the BDP-π web interface to "enable" the USB DAC by clicking "Audio Devices", then the "Enable" button beside your DAC's entry. Then click "Restart".



USB "A" Type

USB "B" Type

## Local Storage Connection

Your BDP-π can accept most USB storage media including thumb drives, buss-powered hard drives, and self-powered hard drives. Available current to power buss-powered drives depends on load from the BDP-π processor. Therefore, Bryston recommends connecting only one USB buss powered drive. Please check the literature that came with your hard drive to determine its power requirements if you have trouble with your drive. Self-powered drives and thumb drives draw very little current so several can be connected at once.

The preferred disk format scheme for USB attached media is FAT32, exFAT, NTFS, and EXT3 are supported as well. Mac OS formatted drives (HFS) are currently read-only, so some features that require disk-write access such as Artist View may not work correctly.

## Network Connection

Your BDP-π features a single 10/100 speed ethernet port designed to connect to your home network router to facilitate control via portable devices or computer, and to obtain internet connection useful for streaming internet radio, downloading firmware updates, and if needed, permit Bryston support personnel to access the unit via service mode upon your request.



Use a CAT-5, CAT-5e, or CAT6 patch cable to connect your BDP-π to an available ethernet port in your room, or directly to your home router.



Successful network connection will be indicated by green and amber LEDs lighting on the BDP-π ethernet port, and by assignment of an IP address by the router. View the IP address on the front panel from the home screen by

pressing the  key. Your IP address begins after eth0. You can use this IP address to access the Bryston Web Interface from any web-enabled device on the same local network as the BDP-π. Enter the IP address in your web browser's address bar. Also, any device running the Bonjour service will respond to the URL <http://bryston-bdp-pi.local> instead of the IP address. All Macintosh computers and iOS have this service built in. Windows computers can run this service once downloaded from the Apple website. Android devices do not currently support Bonjour and must use the numerical IP address.

Since virtually all modern routers assign IP addresses to client devices, this IP address may periodically change which can be a nuisance. To fix your BDP-π's IP address, either invoke the DHCP reservation function in your router, or simply set a Static IP address in Bryston Web Interface. Instructions on how to do so are located in the Firmware User's Manual.

## Wireless Bridge

If you do not have easy access to an ethernet connection in your listening room, you may purchase an after-market "wireless bridge" from most computer electronics stores. Contact Bryston for further information as needed.

Powerline networking kits (HomePlug or similar) may also be used to extend an existing network.

## Network Attached Storage

Add an NAS using the web User Interface. From the Dashboard, click NAS Setup. Select your NAS from the Devices dropdown menu. Share Type, Device Name, and IP Address will automatically fill. Enter the username and password associated with the share and press Next. Select the desired share from the dropdown menu. Then select the subfolder if desired. Press Next. The BDP-π will begin the update scan on the share for playable music and add it to the library.

# Front Panel Menu Navigation

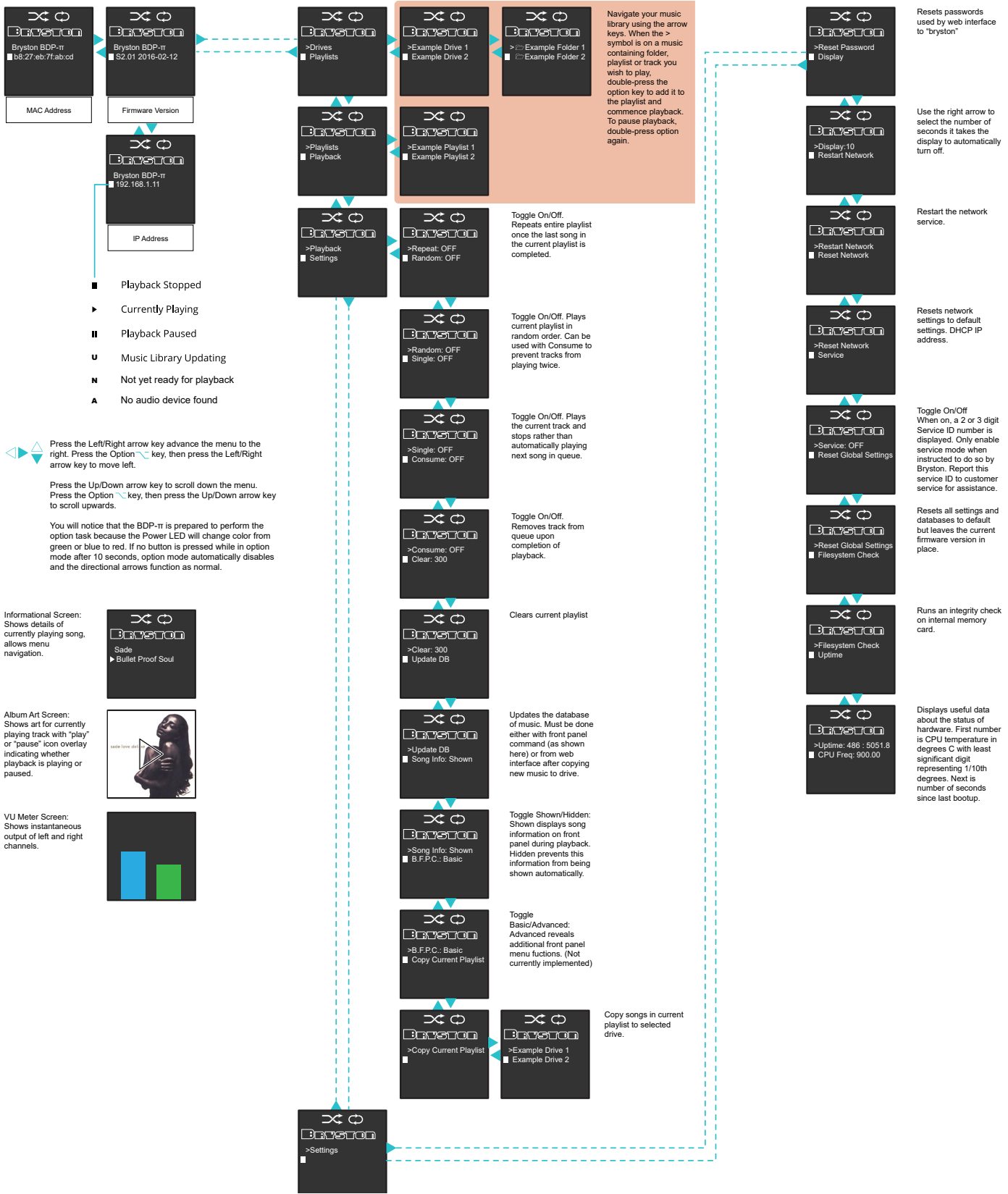

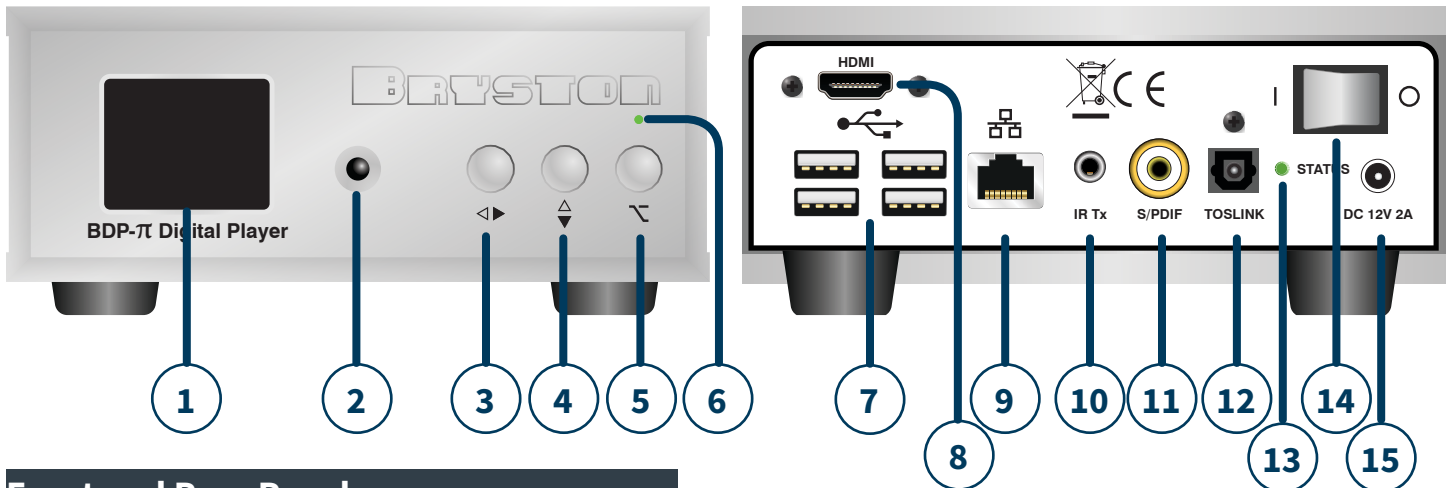

## Front and Rear Panel

### 1. Display:

Indicates information about player, currently playing song, album art, digital “VU” meters, and provides for front panel navigation. Press buttons 3 and 4 simultaneously to cycle through display modes. See “Front Panel Menu Navigation” on page 7 for menu information.

When playing music with USB DAC connected, the display automatically turns off as a compatibility feature.

### 2. Infrared Sensor:

Control the BDP-π with a Bryston BR-2 or universal IR remote control by pointing the device towards this sensor.

### 3. Left / Right Button:

Used for navigating the front panel menu. Pressing this button advances the menu to the right. Press the Option button (Button 5), then press the Left / Right button to move backwards through the menu.

### 4. Up / Down Button:

Used for navigating the front panel menu. Pressing this button scrolls down through the menu incrementally. Press the Option button (Button 5), then press the Up / Down button to move upwards through the menu.

### 5. Option Button:

Press this button to reverse the normal direction

of the directional buttons. For example. The Left / Right button is normally “Right” but when pressing the Option button first, it becomes Left. Up / Down is normally “Down”, but when pressing the Option button first, it becomes “Up”. After pressing option, the Power LED changes color to red indicating the front panel is in option mode and ready to accept the next key press. Pressing option again initiates playback. If no subsequent keypress is made within 10 seconds, the LED turns back to green or blue and normal button directions resume.

### 6. Power LED:

When booting up, this LED lights red. Once ready for playback, it lights green. When the BDP is not powered on, it is unlit. When the blue LED option is configured, the LED lights red during bootup and blue when ready for playback. When the option button is pressed, the LED lights red while awaiting the next key press.

### 7. USB Ports:

Four USB 2.0 type A ports are available. They are bi-directional. You may connect USB storage containing your music library and connect a USB DAC for audio output. When using USB storage, note that the available total output power from the power supply is limited. Bus powered storage such as portable hard drives consume available current. Self powered hard drives and powered USB DACs will have little



impact on the total current.

## 8. HDMI Output:

If you choose to connect your BDP- $\pi$  to a surround processor or DAC with HDMI input, do so with this connector. Note this is an audio-only connection and is limited to a maximum of 2 channels at 48kHz / 16 bit resolution.

## 9. Ethernet Connector:

Connect the BDP- $\pi$  directly to your home network router using a CAT-5 or better cable. If it is inconvenient to do so, you may connect the BDP- $\pi$  to a wireless bridge. The BDP- $\pi$  must be connected to your network to use a tablet, smartphone, or computer to control the unit.

## 10. Infrared Transmitter Output:

Connect the included IR transmitter cable here and stick the IR “eye” over the IR receiver of your Bryston pre-amp to enable the BDP to control certain aspects of your auxiliary Bryston hardware. This feature is currently experimental.

## 11. S/PDIF Digital Audio Output:

Connect the BDP- $\pi$  to your DAC’s S/PDIF input using a digital coaxial interconnect.

## 12. Toslink Optical Audio Output:

Connect the BDP- $\pi$  to your DAC’s TOSLINK input using an optical digital audio interconnect.

## 13. Status Light:

The Status LED indicates various error states as follows:

**Blue:** BDP- $\pi$  is not receiving enough voltage to operate.

**Green:** Normal operation.

**Red:** BDP- $\pi$  is receiving too much voltage. Unit will not operate.

## 14. Power Switch:

Once you have connected the external power supply to the input (item 15), switch the BDP on by moving the rocker switch towards the | side. This applies power to the BDP- $\pi$  and causes it to

boot up. To power off the unit, move the switch to the O side.

## 15. DC Power Connector:

Apply power to the BDP- $\pi$  by connecting the included 2 Ampere power supply to this port. The IEC-320 end of the power supply should be connected to your AC mains power. You may optionally connect the BDP- $\pi$  to a Bryston power supply such as the MPS-2 or PS-3 by requesting an adapter from Bryston. However, this limits total available current to 500mA which may prevent you from using buss powered USB storage with the BDP- $\pi$ .

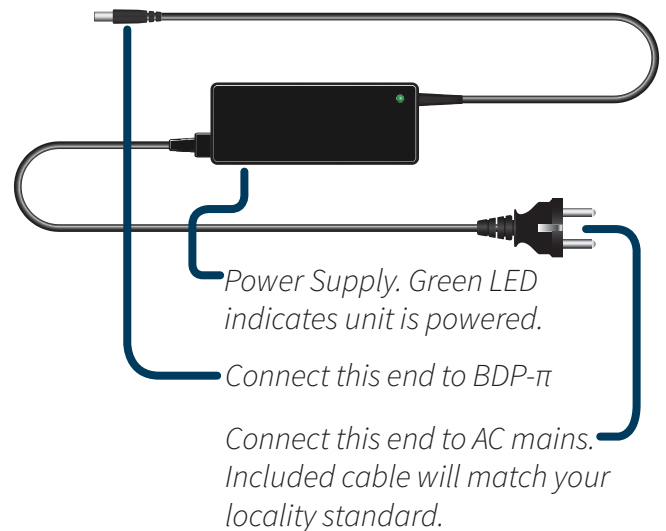

## Dimensions

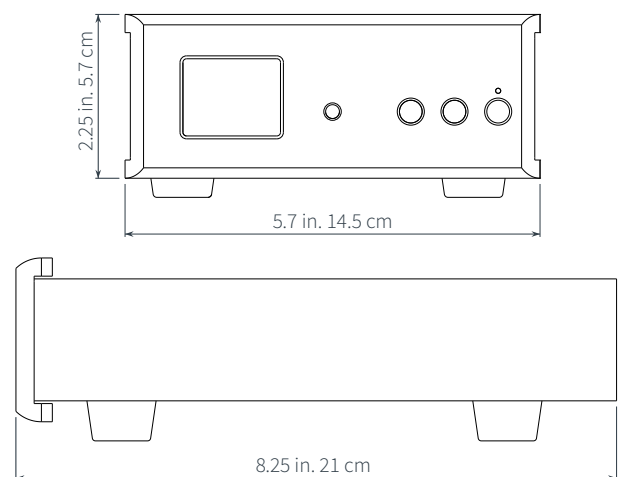

## Software Introduction

At the time of writing, the current firmware on your BDP-π is a version we call Manic Moose. Manic Moose describes the Bryston engineered firmware running including our user interface. Unlike many other products, the BDP can be operated entirely within the web browser of a portable controller such as an iPhone, iPad, Android device, desktop or laptop computer. As such, there is no need to download an app. On all devices but Android, simply open the web browser on your device and enter the following address:

**<http://bryston-bdp-pi.local>**

Android devices require the numerical IP address shown on the front display of the unit.

You will see the "Dashboard" for your player.

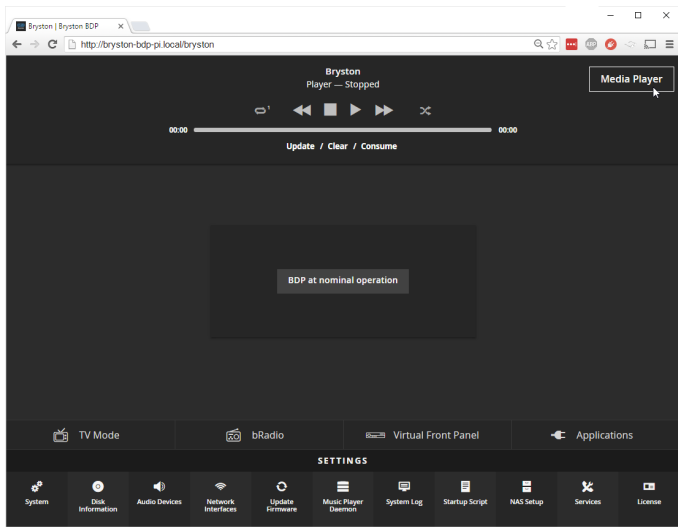

The Dashboard provides access to a variety of settings, technical player information, system notifications, and most importantly, media. Media Player is used to access your personal music library stored on an NAS or USB attached drive. bRadio is an internet radio directory, and Applications allows access to Tidal online streaming service.

Within the scope of this brief introduction, we shall explore Media Player. Please visit [support.bryston.com](http://support.bryston.com) to access the Manic Moose User Manual for an indepth exploration of all features built into Manic Moose.

## Media Player

Clicking or tapping Media Player from the Dashboard takes you to the Media Player where you will spend the most time enjoying your music. Note that our web application is fully responsive and re-oriens itself depending on landscape or portrait orientation of your device. For brevity, illustrations below are for landscape orientation.

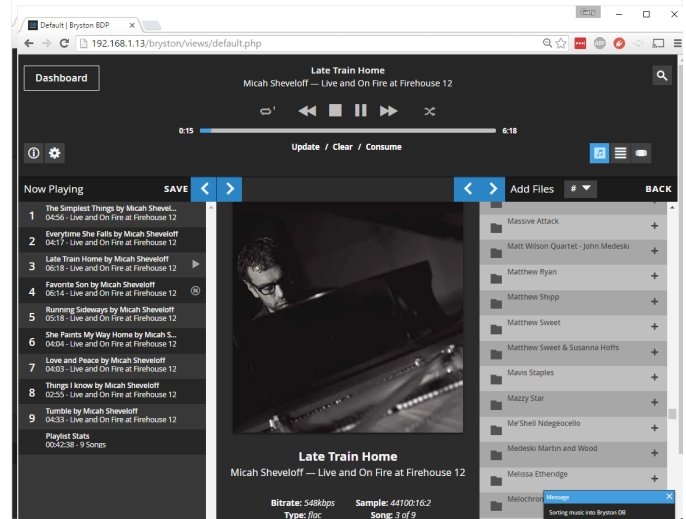

The Media Player can be understood by recognizing four distinct areas: Transport Control (the horizontal header), and the three vertical columns beneath it. Left to right, they are the Now Playing area which is your current queue, Current Track which shows album art, artist, song title, album name, and resolution for the currently playing song, and Add Files which provides hierarchical access to your music library.

## Now Playing

To play music, add music from your library to the queue. You can browse your music sorted into folders just like it is organized on your drive, or by select metadata tags such as artist name or album name.

You can add entire artist collections, single albums, single tracks or a combination thereof to the cue to form a playlist. Simply click or tap the + icon beside any field, folder, or track name to add that item and all music contained beneath it to the queue. The illustration above shows 9 tracks from an album in

the queue.

Once tracks are placed into the Now Playing queue, they can be reordered or removed from the queue entirely. Click or tap-and-hold the track number then drag it into the desired position in the queue to reorder or onto the Now Playing area to remove. To clear the entire playlist, click or tap the Clear instruction beneath the track timeline in the Transport Control area.

## Stored Playlists

Store any Now Playing queue for future recall by clicking SAVE in the Now Playing area. Title the playlist and click Save.

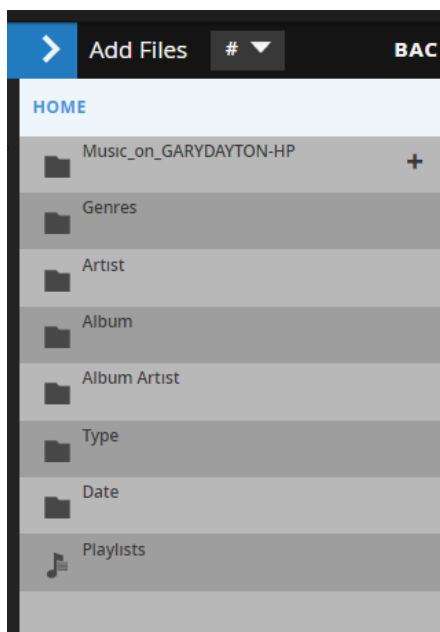
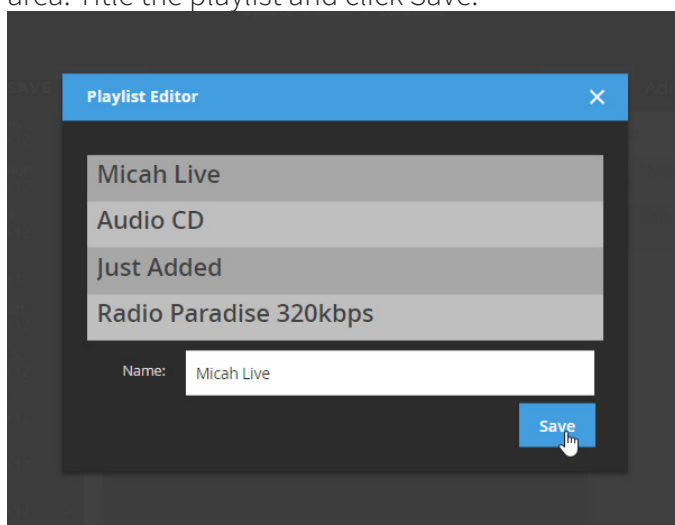

Recall saved playlists by clicking Playlists in the Add Files area.

## Alternate Views

Clicking  brings up the Song View which displays a table of information for songs in the current queue.

Clicking  brings up the Artist View which lists artists down the narrow left column. Clicking on any artist displays albums by that artist.

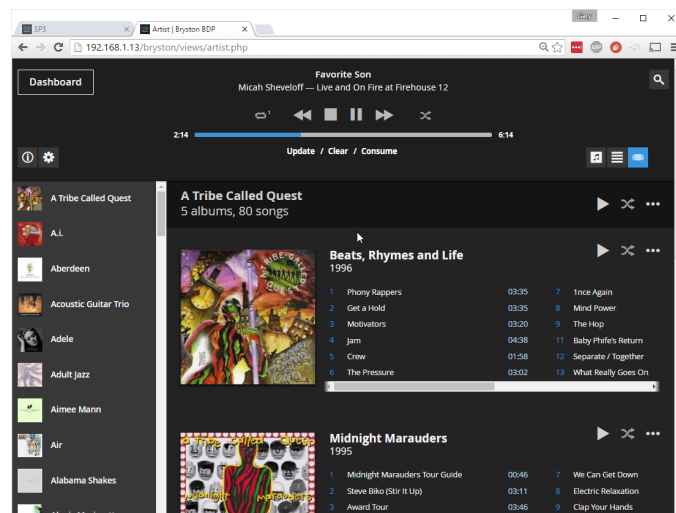

## Adding Music to Library

The BDP- $\pi$  shares any USB attached media over the local network by default allowing users to move music onto the BDP- $\pi$ 's attached media over the network. Mac and PC computers will find the BDP- $\pi$  under Network in Finder and File Explorer respectively. Click on the share, login with bryston as both the login and password. You may now copy music to the drive.

The BDP- $\pi$  will not automatically recognize new files added to the drive. Re-index the music drive by clicking or tapping the Update text in the Transport Control area. Update will appear in blue during the re-indexing process and will return to white when done.

Bryston Limited | 677 Neal Drive | Peterborough, Ontario K9J 6X7  
Canada | Phone: 705-742-5325 | [www.bryston.com](http://www.bryston.com)